

City of Phoenix Standard Utility Locations

Engineering and Architectural Services Department

February 2009





City of Phoenix

STANDARD UTILITY
LOCATIONS FOR THE CITY OF
PHOENIX

Prepared by the

STANDARD UTILITY LOCATIONS COMMITTEE
CITY OF PHOENIX, ARIZONA

February 2009

TABLE OF CONTENTS

	<u>Page</u>
Introduction.....	1
Purpose.....	1
Scope.....	1-2
Design Standards.....	2
Standard Utility Location Details	
Drawing A: Plan View and Cross Section of 140' ROW w/Median	3
Drawing B: Plan View and Cross Section of 130' ROW w/Median	4
Drawing C: Plan View and Cross Section of 110' ROW w/Median	5
Drawing D: Plan View and Cross Section of 100' ROW w/Median	6
Drawing E: Plan View and Cross Section of 80' ROW w/Median	7
Drawing F: Cross Section of 60' ROW – Commercial/Residential	8
Drawing G: Cross Section of 60' ROW – Commercial/Residential	9
Drawing H: Cross Section of 50' ROW – Single Family Residential	10
Drawing I: Cross Section of 50' ROW – Single Family Residential	11
Drawing J: Plan View of 70' ROW/70' ROW – Intersection w/Median	12
Drawing K: Plan View of 70' ROW/65' ROW – Intersection w/Median	13
Drawing L: Plan View of 70' ROW/55' ROW – Intersection w/Median	14
Drawing M: Plan View of 70' ROW/50' ROW – Intersection w/Median	15
Drawing N: Plan View of 70' ROW/40' ROW – Intersection w/Median	16
Drawing O: Plan View of 65' ROW/55' ROW – Intersection w/Median	17
Drawing P: Plan View of 65' ROW/50' ROW – Intersection w/Median	18
Drawing Q: Plan View of 65' ROW/40' ROW – Intersection w/Median	19
Drawing R: Plan View of 55' ROW/50' ROW – Intersection w/Median	20
Drawing S: Plan View of 55' ROW/40' ROW – Intersection w/Median	21
Drawing T: Plan View of 50' ROW/40' ROW – Intersection w/Median	22
Special Acknowledgements.....	23



Special thanks to members of the City of Phoenix
Standard Utility Locations Committee:

ENGINEERING & ARCHITECTURAL SERVICES DEPARTMENT

Thomas Fisher
Carlos Lara

STREET TRANSPORTATION DEPARTMENT

Gary Boesch
Ralph Goodall

DEVELOPMENT SERVICES DEPARTMENT

Larry Smith

WATER SERVICES DEPARTMENT

INTRODUCTION

Over 30 years ago, there was widespread opinion of an increasing need for standard locations for utilities within the rights-of-way of the City of Phoenix. Because of the need for study, a committee was formed consisting of representatives from the American Telephone and Telegraph Company (AT&T), Arizona Public Service Company (APS), Arizona Highway Department, Maricopa County Highway Department, Mountain Bell, Salt River Power District, Salt River Valley Water Users' Association, City of Phoenix Water and Sewers Department, City of Phoenix Planning Department, City of Phoenix Division of Real Estate, and the Home Builders Association of Central Arizona. The locations for utilities indicated in that report did not satisfy each organization's preferences, but the study concluded that all of the utilities must be located within the right-of-way. The committee agreed that the locations were the best that could be accomplished at that point in time, but if corrections were needed in the future, it was expected that the corrections would be a result of further study and fact-finding.

After further extensive study of the 1970 version of the standard utility locations, the City of Phoenix Engineering & Architectural Services Department's Utility Coordination Section spearheaded an effort to update these locations. Over the past three years, the Utility Coordination Section has worked closely with the City of Phoenix Water Services Department, City of Phoenix Development Services Department, City of Phoenix Street Transportation Department, and the Arizona Utility Coordination Committee to ensure the proposed revisions to these standard utility locations are practical and applicable.

PURPOSE

The urban underground has become a maze of utility lines, including cable television, fiber optics, gas, electricity, water and wastewater pipelines. In some locations, petroleum and gas pipelines, mass transit and communication lines all compete for the underground right-of-way space to place their facilities. Therefore proper planning must be exercised for the placement of these utilities in the City of Phoenix rights-of-way to avoid conflicts of one with another. It is expected that this assignment of space will better utilize the area within the right-of-way, provide for fewer points of conflict in the construction of utilities, and save considerable amount of time and money. Furthermore, utilities should be placed underground according to a standard arrangement to protect the public health and safety and to facilitate locating the facilities to make necessary repairs.

SCOPE

This manual is limited to the City of Phoenix and those cross sections adopted by the City of Phoenix Street Classification Map. This manual has encompassed all utilities and facilities which presently exist within the public rights-of-way within the city. Space has been assigned even though there may be no need for that particular utility within every street covered by that cross section. All utilities located within the City of Phoenix

rights-of-way for new road construction shall be in accordance with the Standard Utility Details in this manual based on width of right-of-way and pavement width. This manual covers every kind of right-of-way adopted by the City of Phoenix Street Classification Map and replaces all previous standard utility location manuals.

DESIGN STANDARDS

These standard utility locations are presented with the realization that not every case will be covered or the locations are not applicable or obtainable. Special conditions and new technology may preclude the practical application of these standards. Therefore, some adjustments will have to be made to these cross sections. These adjustments must be reviewed by the appropriate utility agencies along with members of the Standard Utility Locations Committee.

When street elevations, alignments, or widths are modified, utilities are sometimes required to relocate. Frequently in those instances, standard locations are inapplicable due to an already crowded right-of-way. Therefore these standards will apply primarily to new development and existing development where converting overhead into underground facilities is planned.

This manual shall serve as a guide to all utility work within City of Phoenix rights-of-way. Utility companies are not required to revise their facility locations primarily for the purpose of conformity to this manual. However, in those instances where new or relocation is required or undertaken, these standards shall be adhered to wherever practical. It is hereby determined to the following:

1. No vertical dimensions will be shown within these standards because of gravity flow of some utilities and because of difficulty of terrain and underground formations.
2. All utility installations shall conform to the current Maricopa Association of Governments (MAG) Uniform Standard Specifications and Details for Public Works Construction including the current City of Phoenix Supplements to MAG and the latest edition of the Design Standards Manual for Water and Wastewater Systems as prepared by the City of Phoenix Water Services Department.
3. All utilities will attempt to utilize a common trench (joint trench) wherever feasible and technologically possible.
4. Provisions shall be made for known or planned expansions of utilities and/or future modifications to the street when new utility installations or adjustments to existing facilities are proposed.

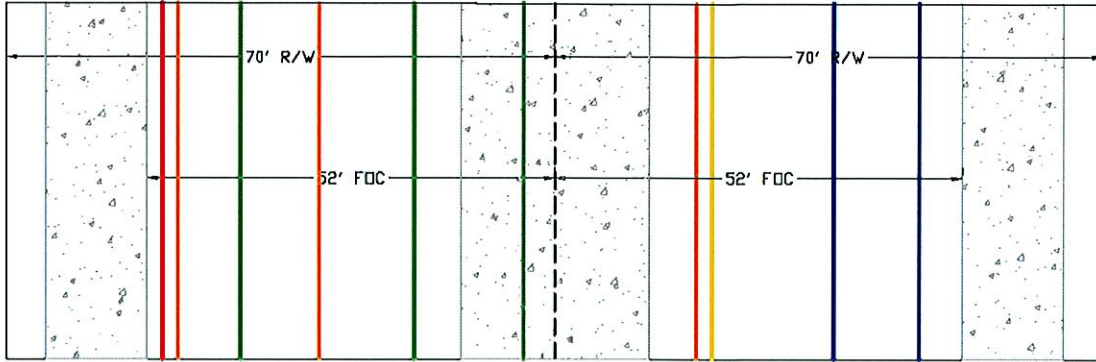

LOOKING NORTH OR WEST

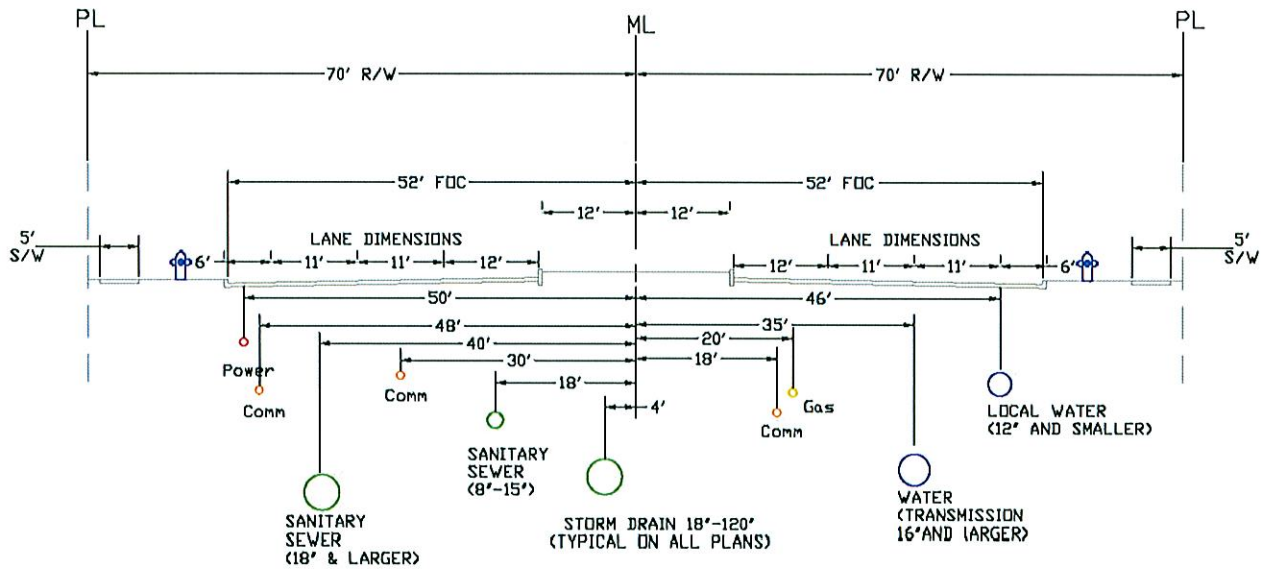

*NOTE: ALL DIMENSIONS ARE FROM MONUMENT LINE OF ROAD TO CENTER LINE OF PIPE.

LANE DIMENSIONS ARE FOR INFORMATIONAL PURPOSES.

ALL PRIVATE AND PUBLIC OWNED UTILITY LINES SHALL MAINTAIN A 6' (MIN.) OUTSIDE TO OUTSIDE HORIZONTAL CLEARANCE FROM ALL CITY-OWNED WATER AND SEWER LINES.



**STANDARD UTILITY DETAILS -
PLAN VIEW AND CROSS SECTION OF 140' TO
RIGHT OF WAY WITH MEDIAN ISLANDS**

ENGINEERING AND
ARCHITECTURAL SERVICES
DEPARTMENT

DATE
7/28/2004

DRAWN BY
THOMAS FISHER

DRAWING NO.
A

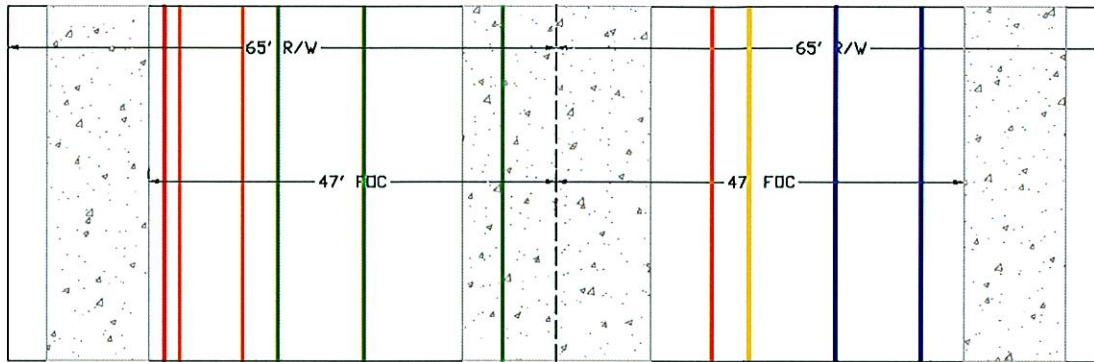

LOOKING NORTH OR WEST

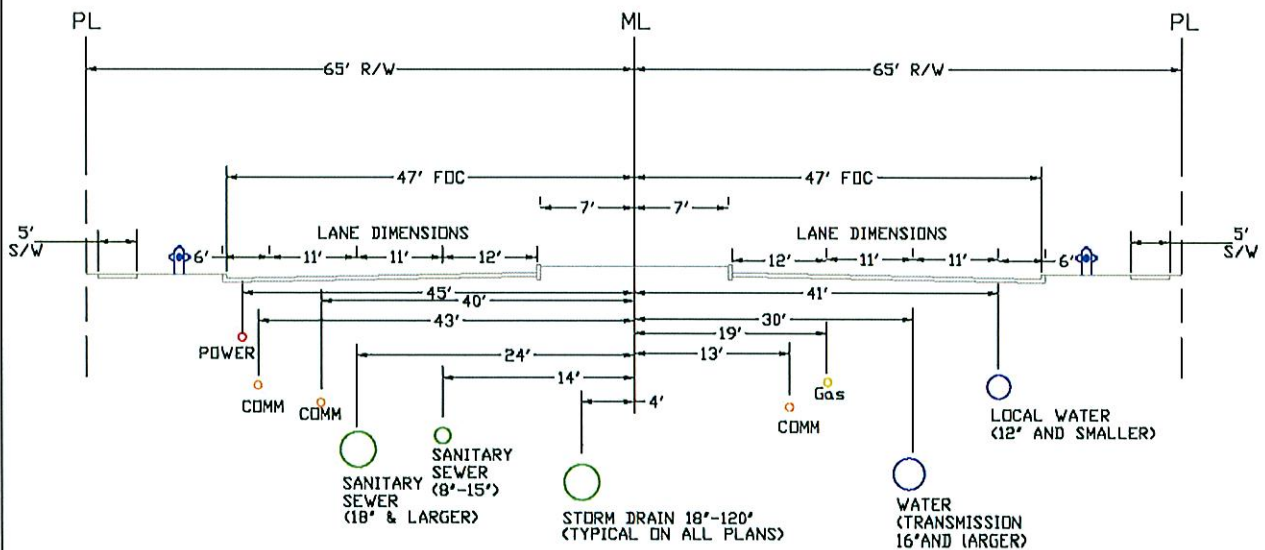

*NOTE: ALL DIMENSIONS ARE FROM MONUMENT LINE OF ROAD TO CENTER LINE OF PIPE.

LANE DIMENSIONS ARE FOR INFORMATIONAL PURPOSES.

ALL PRIVATE AND PUBLIC OWNED UTILITY LINES SHALL MAINTAIN A 6' (MIN.) OUTSIDE TO OUTSIDE HORIZONTAL CLEARANCE FROM ALL CITY-OWNED WATER AND SEWER LINES.



STANDARD UTILITY DETAILS - PLAN VIEW AND CROSS SECTION OF 130' TO RIGHT OF WAY WITH MEDIAN ISLANDS

ENGINEERING AND
ARCHITECTURAL SERVICES
DEPARTMENT

DATE
7/28/2004

DRAWN BY
THOMAS FISHER

DRAWING NO.
B

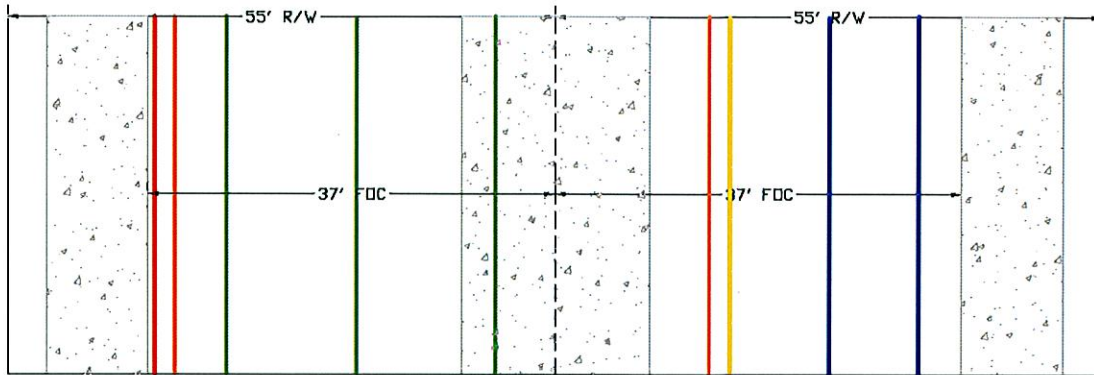

LOOKING NORTH OR WEST

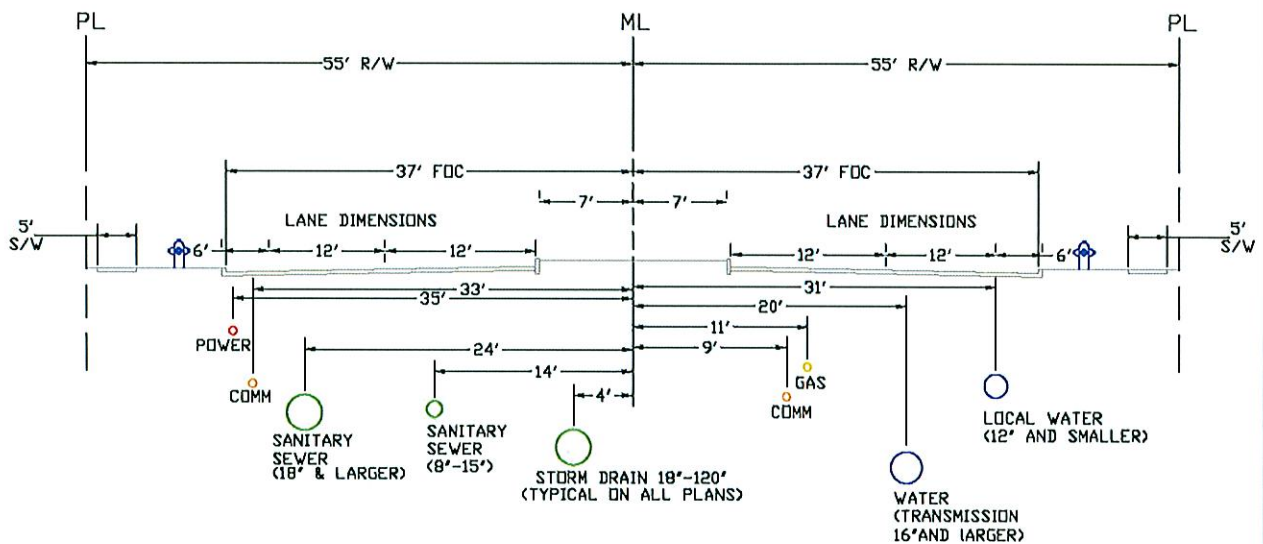

*NOTE: ALL DIMENSIONS ARE FROM MONUMENT LINE OF ROAD TO CENTER LINE OF PIPE.
LANE DIMENSIONS ARE FOR INFORMATIONAL PURPOSES.

ALL PRIVATE AND PUBLIC OWNED UTILITY LINES SHALL MAINTAIN A 6' (MIN.)
OUTSIDE TO OUTSIDE HORIZONTAL CLEARANCE FROM ALL CITY-OWNED WATER
AND SEWER LINES.



STANDARD UTILITY DETAILS - PLAN VIEW AND CROSS SECTION OF 110' TO RIGHT OF WAY WITH MEDIAN ISLANDS

ENGINEERING AND
ARCHITECTURAL SERVICES
DEPARTMENT

DATE
7/28/2004

DRAWN BY
THOMAS FISHER

DRAWING NO.
C

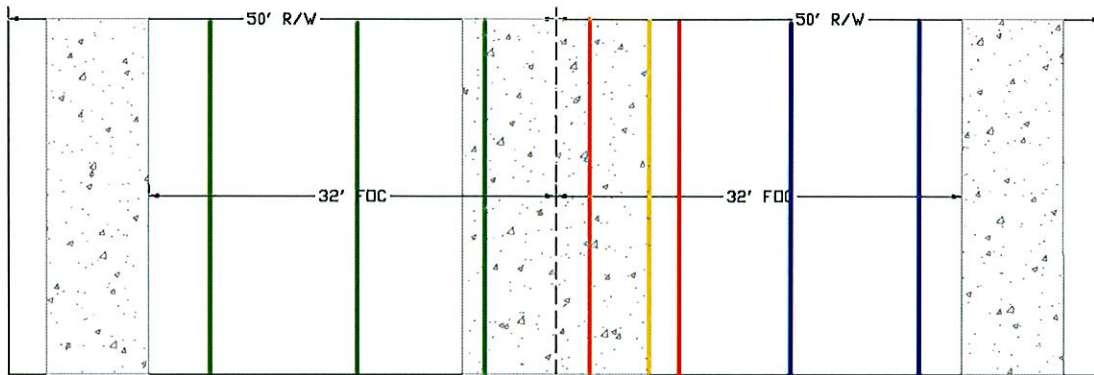

LOOKING NORTH OR WEST

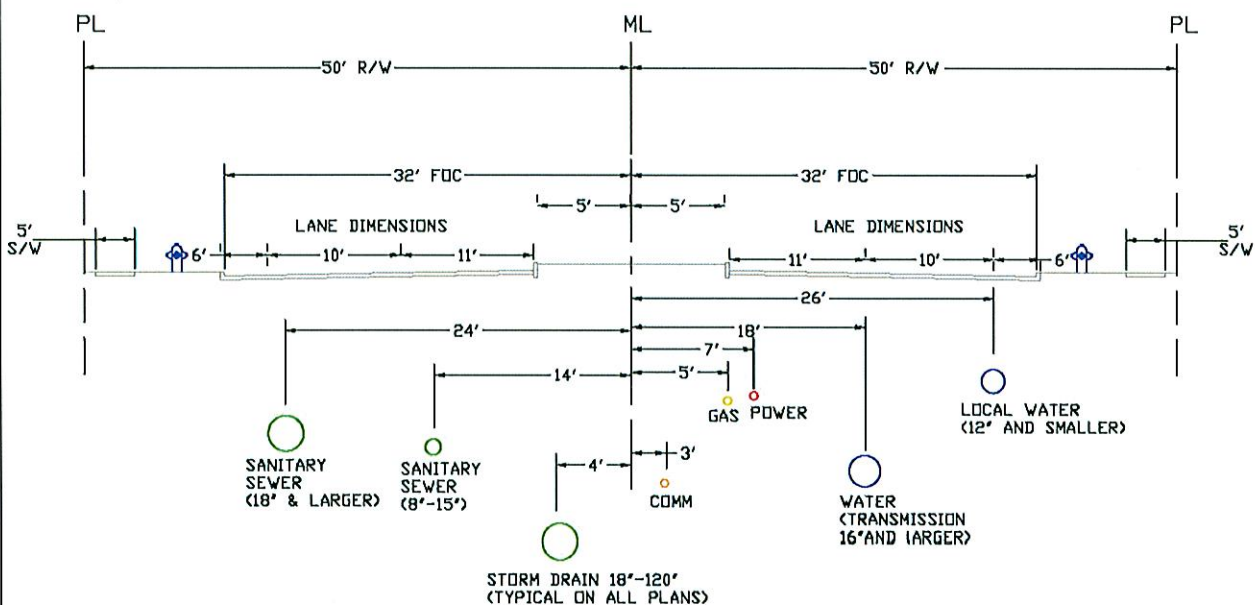

*NOTE: ALL DIMENSIONS ARE FROM MONUMENT LINE OF ROAD TO CENTER LINE OF PIPE.
 LANE DIMENSIONS ARE FOR INFORMATIONAL PURPOSES.
 ALL PRIVATE AND PUBLIC OWNED UTILITY LINES SHALL MAINTAIN A 6' (MIN.)
 OUTSIDE TO OUTSIDE HORIZONTAL CLEARANCE FROM ALL CITY-OWNED WATER
 AND SEWER LINES.



**STANDARD UTILITY DETAILS -
 PLAN VIEW AND CROSS SECTION OF 100' TO
 RIGHT OF WAY WITH MEDIAN ISLANDS**

ENGINEERING DEPARTMENT	DATE 7/29/2004	DRAWN BY THOMAS FISHER	DRAWING NO. D
---------------------------	-------------------	---------------------------	------------------

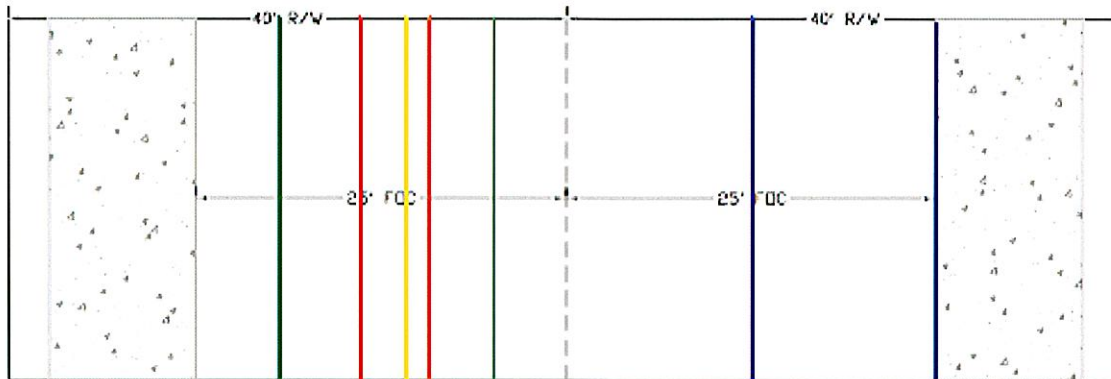

LOOKING NORTH OR WEST

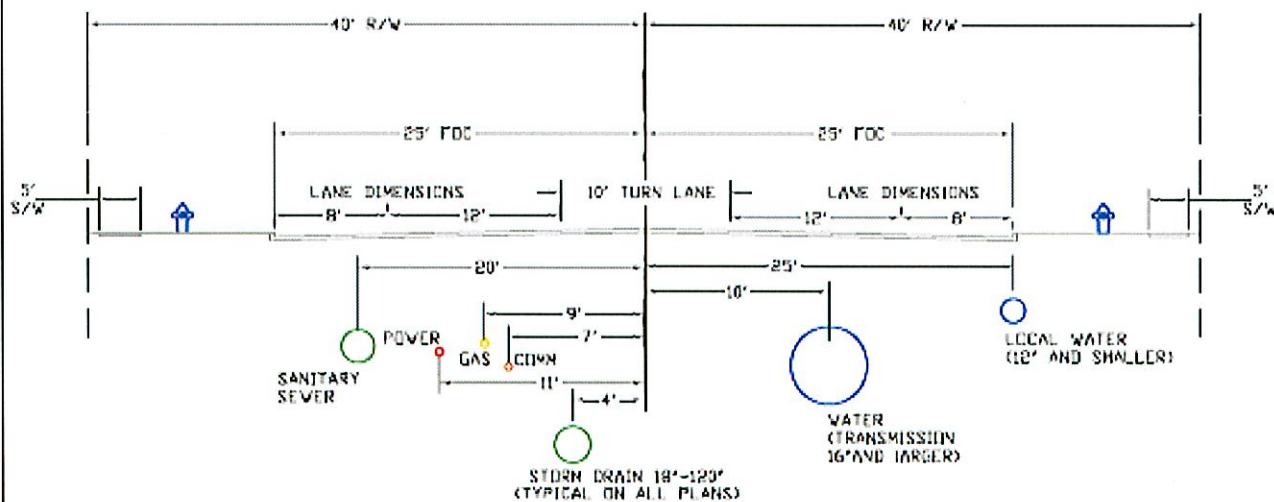

*NOTE: ALL DIMENSIONS ARE FROM MONUMENT LINE OF ROAD TO CENTER LINE OF PIPE.

LANE DIMENSIONS ARE FOR INFORMATIONAL PURPOSES.

ALL PRIVATE AND PUBLIC OWNED UTILITY LINES SHALL MAINTAIN A 6' (MIN.) OUTSIDE TO OUTSIDE HORIZONTAL CLEARANCE FROM ALL CITY-OWNED WATER AND SEWER LINES.



STANDARD UTILITY DETAILS - PLAN VIEW AND CROSS SECTION OF 80' TO RIGHT OF WAY WITH MEDIAN ISLANDS

ENGINEERING AND
ARCHITECTURAL SERVICES
DEPARTMENT

DATE
3/6/2007

DRAWN BY
THOMAS FISHER

DRAWING NO.
E

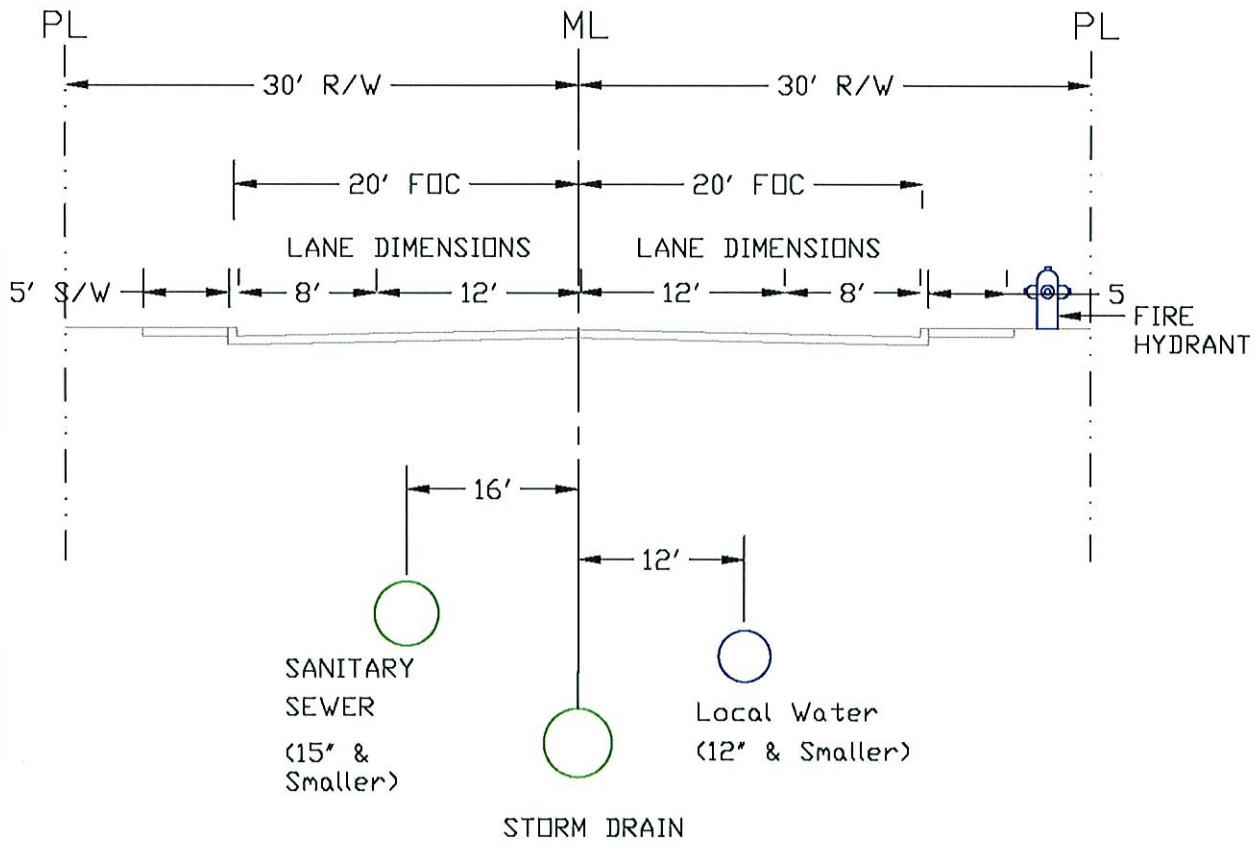

LOOKING NORTH OR WEST

***NOTE:** ALL DIMENSIONS ARE FROM MONUMENT LINE OF ROAD TO CENTER LINE OF PIPE.

ALL UTILITIES NOT SHOWN e.g. ELECTRIC, GAS, TELEPHONE, ETC., SHALL BE PLACED IN ADJACENT PUBLIC UTILITY EASEMENT (P.U.E) LOOKING NORTH TO WEST

LANE DIMENSIONS ARE FOR INFORMATIONAL PURPOSES

ALL PRIVATE AND PUBLIC OWNED UTILITY LINES SHALL MAINTAIN A 6' (MIN.) OUTSIDE TO OUTSIDE HORIZONTAL CLEARANCE FROM ALL CITY-OWNED WATER AND SEWER LINES



STANDARD UTILITY DETAILS - CROSS SECTION OF 60' RIGHT OF WAY - COMMERCIAL / RESIDENTIAL

ENGINEERING AND ARCHITECTURAL SERVICES DEPARTMENT	DATE 7/28/2004	DRAWN BY THOMAS FISHER	DRAWING NO. F
---	-------------------	---------------------------	------------------

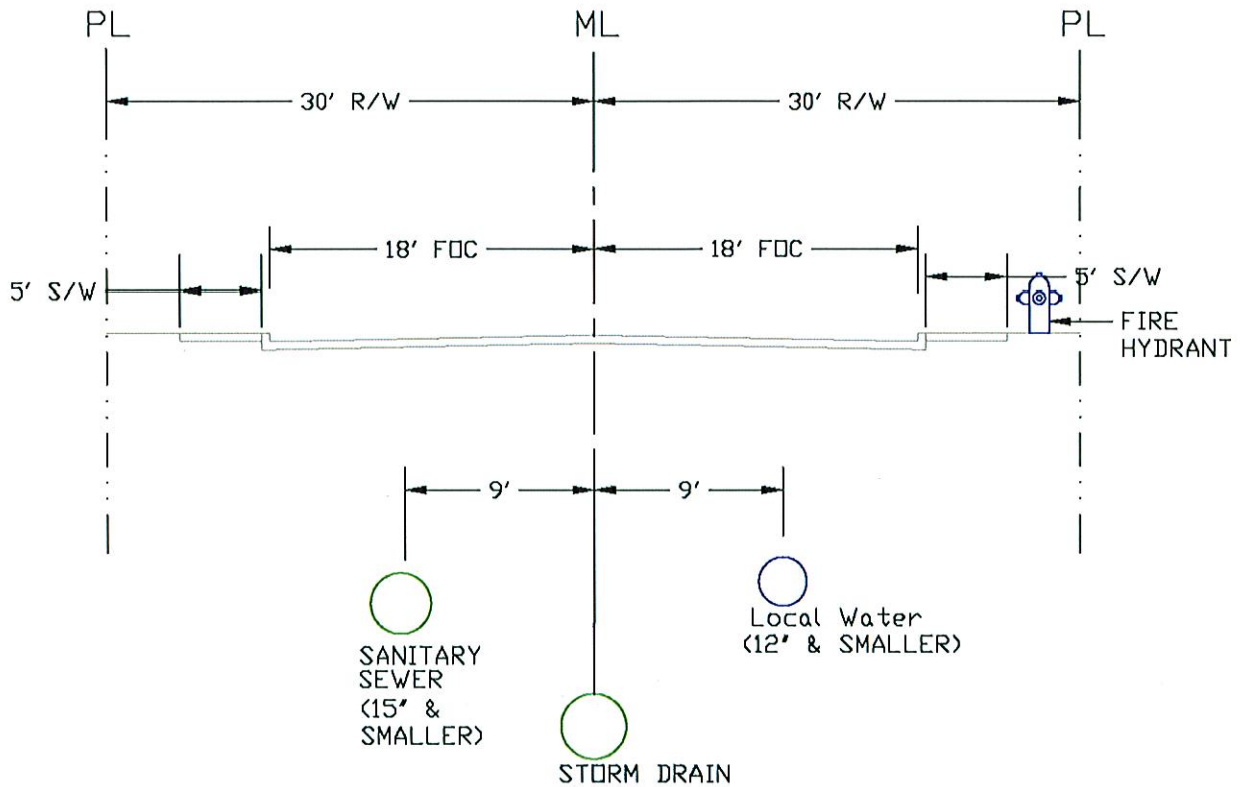

LOOKING NORTH OR WEST

*NOTE: ALL DIMENSIONS ARE FROM MONUMENT LINE OF ROAD TO CENTER LINE OF PIPE.

ALL UTILITIES NOT SHOWN e.g. ELECTRIC, GAS, TELEPHONE, ETC., SHALL BE PLACED IN ADJACENT PUBLIC UTILITY EASEMENT (P.U.E) LOOKING NORTH TO WEST

LANE DIMENSIONS ARE FOR INFORMATIONAL PURPOSES

ALL PRIVATE AND PUBLIC OWNED UTILITY LINES SHALL MAINTAIN A 6' (MIN.) OUTSIDE TO OUTSIDE HORIZONTAL CLEARANCE FROM ALL CITY-OWNED WATER AND SEWER LINES



STANDARD UTILITY DETAILS - CROSS SECTION OF 50' RIGHT OF WAY- COMMERCIAL/RESIDENTIAL

ENGINEERING AND ARCHITECTURAL SERVICES DEPARTMENT

DATE
7/28/2004

DRAWN BY
THOMAS FISHER

DRAWING NO.
G

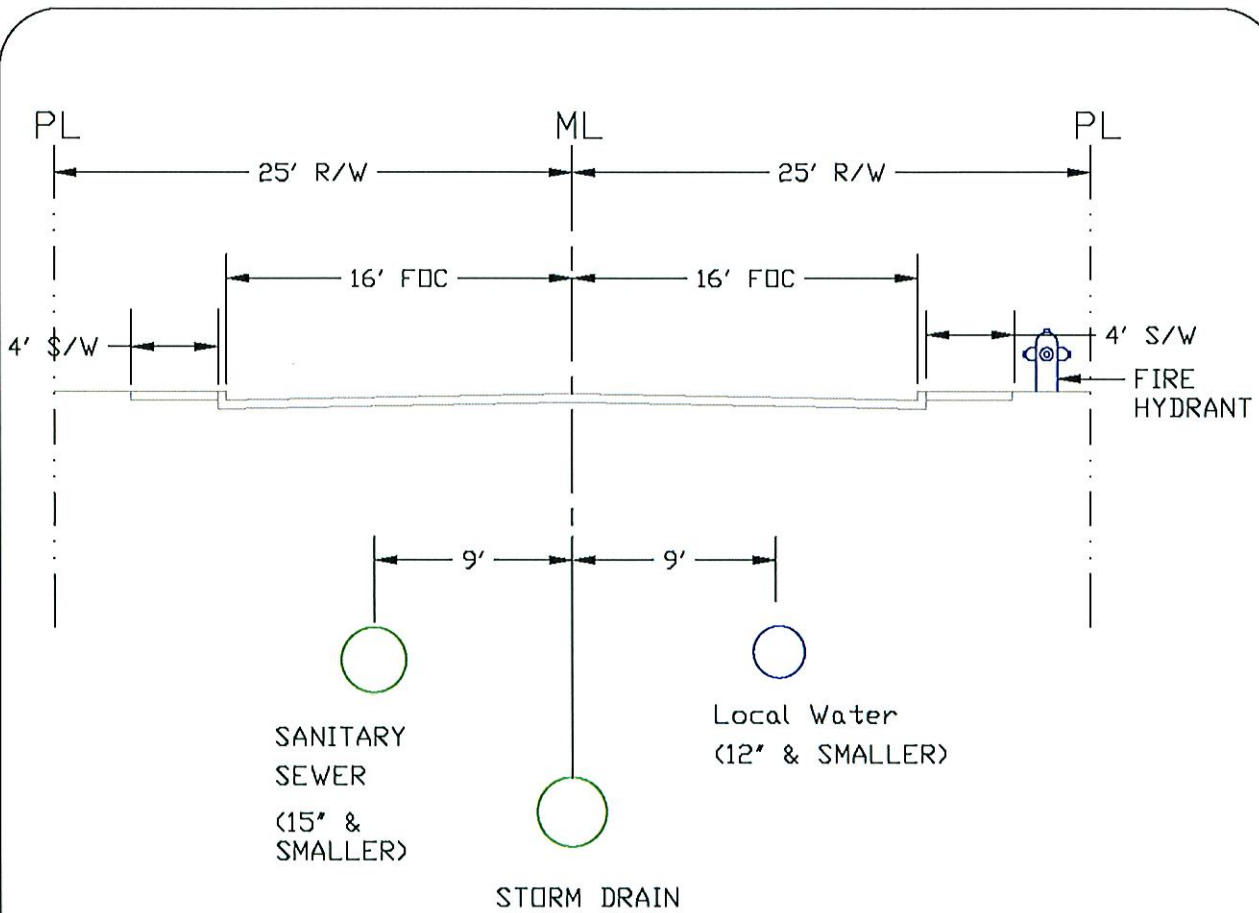

LOOKING NORTH OR WEST

*NOTE: ALL DIMENSIONS ARE FROM MONUMENT LINE OF ROAD TO CENTER LINE OF PIPE.

ALL UTILITIES NOT SHOWN e.g. ELECTRIC, GAS, TELEPHONE, ETC., SHALL BE PLACED IN ADJACENT PUBLIC UTILITY EASEMENT (P.U.E) LOOKING NORTH TO WEST

LANE DIMENSIONS ARE FOR INFORMATIONAL PURPOSES

ALL PRIVATE AND PUBLIC OWNED UTILITY LINES SHALL MAINTAIN A 6' (MIN.) OUTSIDE TO OUTSIDE HORIZONTAL CLEARANCE FROM ALL CITY-OWNED WATER AND SEWER LINES



STANDARD UTILITY DETAILS - CROSS SECTION OF 50' RIGHT OF WAY- SINGLE FAMILY RESIDENTIAL

ENGINEERING AND
ARCHITECTURAL SERVICES
DEPARTMENT

DATE
7/27/2004

DRAWN BY
THOMAS FISHER

DRAWING NO.
H

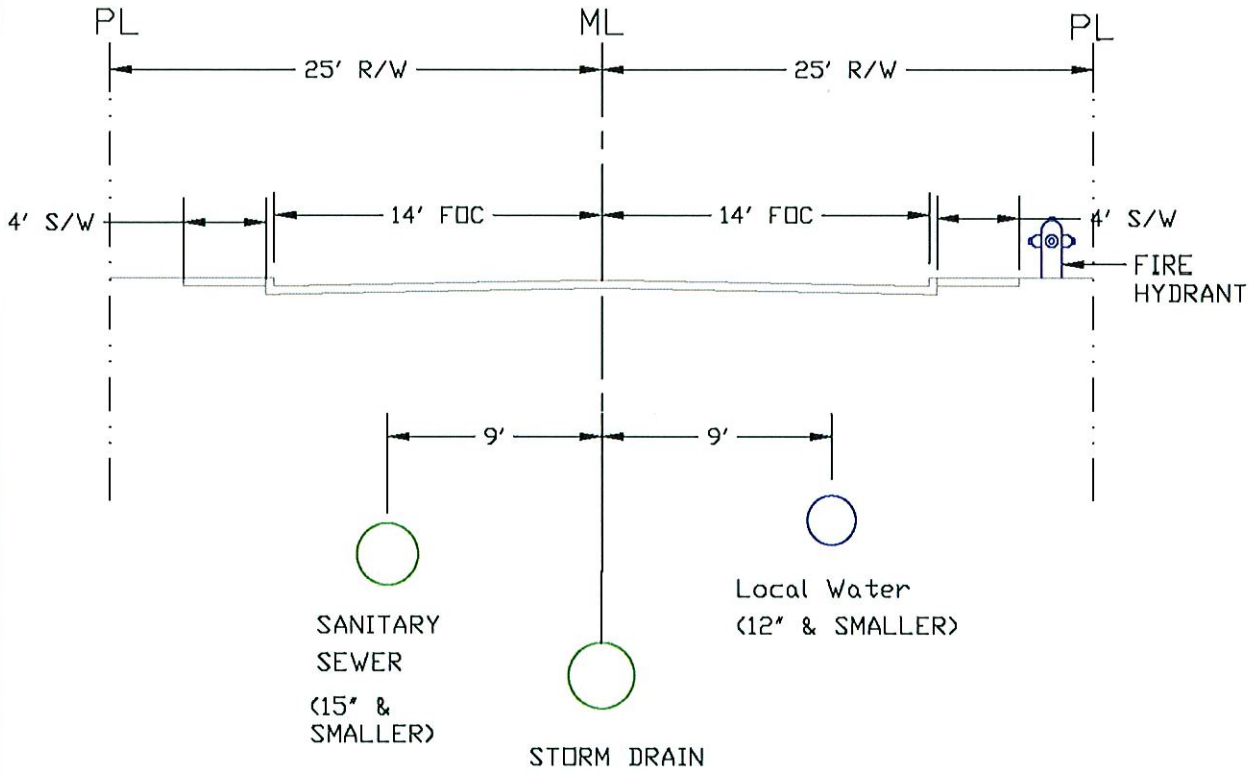

LOOKING NORTH OR WEST

*NOTE: ALL DIMENSIONS ARE FROM MONUMENT LINE OF ROAD TO CENTER LINE OF PIPE.

ALL UTILITIES NOT SHOWN e.g. ELECTRIC, GAS, TELEPHONE, ETC., SHALL BE PLACED IN ADJACENT PUBLIC UTILITY EASEMENT (P.U.E) LOOKING NORTH TO WEST

LANE DIMENSIONS ARE FOR INFORMATIONAL PURPOSES

ALL PRIVATE AND PUBLIC OWNED UTILITY LINES SHALL MAINTAIN A 6' (MIN.) OUTSIDE TO OUTSIDE HORIZONTAL CLEARANCE FROM ALL CITY-OWNED WATER AND SEWER LINES



STANDARD UTILITY DETAILS - CROSS SECTION OF 50' RIGHT OF WAY - SINGLE FAMILY RESIDENTIAL

ENGINEERING AND ARCHITECTURAL SERVICES DEPARTMENT

DATE
7/28/2004

DRAWN BY
THOMAS FISHER

DRAWING NO.
1

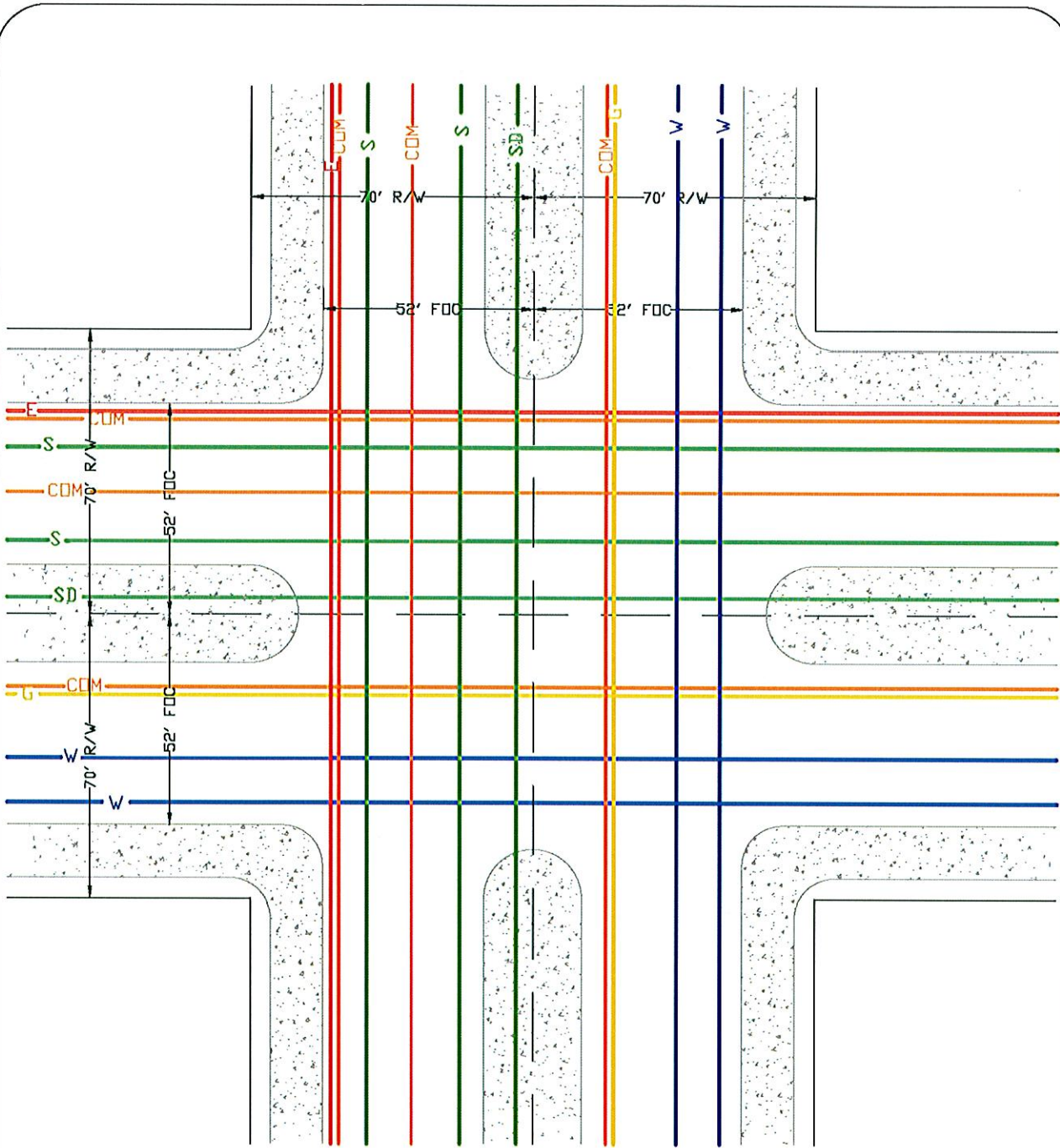

**STANDARD UTILITY DETAILS - PLAN VIEW
70' ROW / 70' ROW INTERSECTION
WITH MEDIAN ISLANDS**

ENGINEERING AND
ARCHITECTURAL SERVICES
DEPARTMENT

DATE
7/28/2004

DRAWN BY
THOMAS FISHER

DRAWING NO.
J

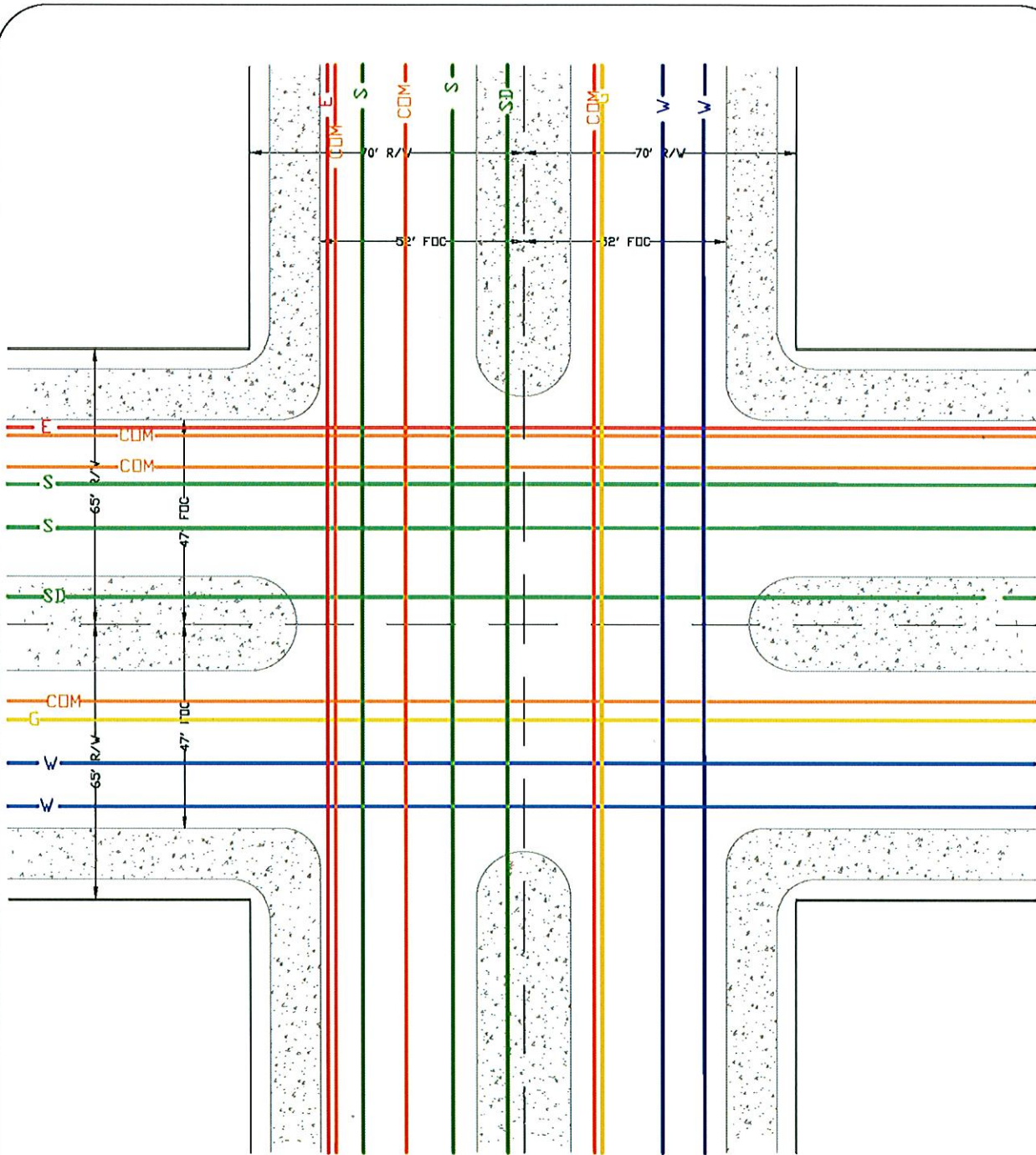

**STANDARD UTILITY DETAILS - PLAN VIEW
70' ROW / 65' ROW INTERSECTION
WITH MEDIAN ISLANDS**

ENGINEERING DEPARTMENT	DATE 7/28/2004	DRAWN BY THOMAS FISHER	DRAWING NO. K
---------------------------	-------------------	---------------------------	------------------

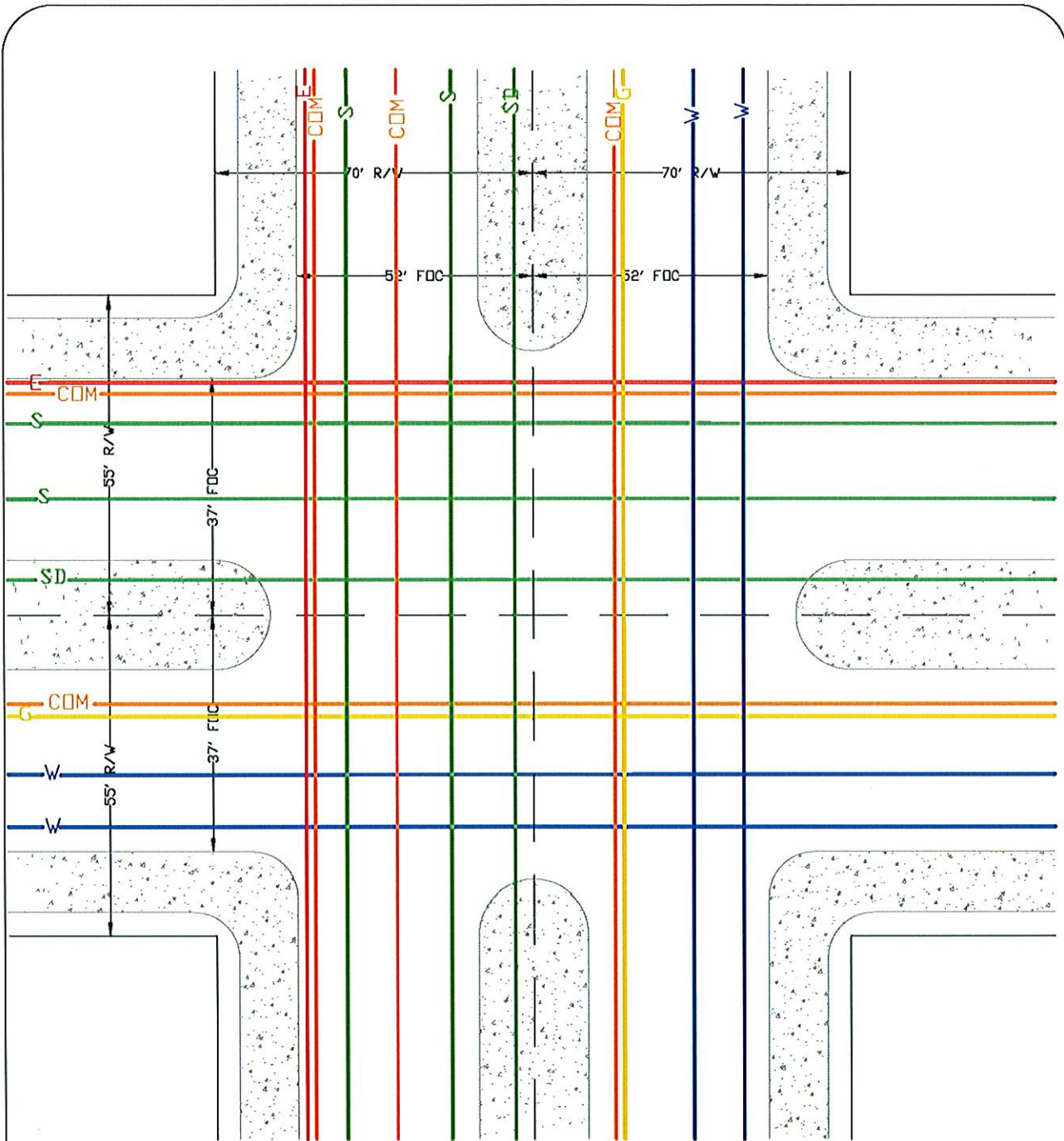

City of Phoenix

**STANDARD UTILITY DETAILS - PLAN VIEW
70' ROW / 55' ROW INTERSECTION
WITH MEDIAN ISLANDS**

ENGINEERING AND ARCHITECTURAL SERVICES DEPARTMENT

DATE
7/28/2004

DRAWN BY
THOMAS FISHER

DRAWING NO.
L

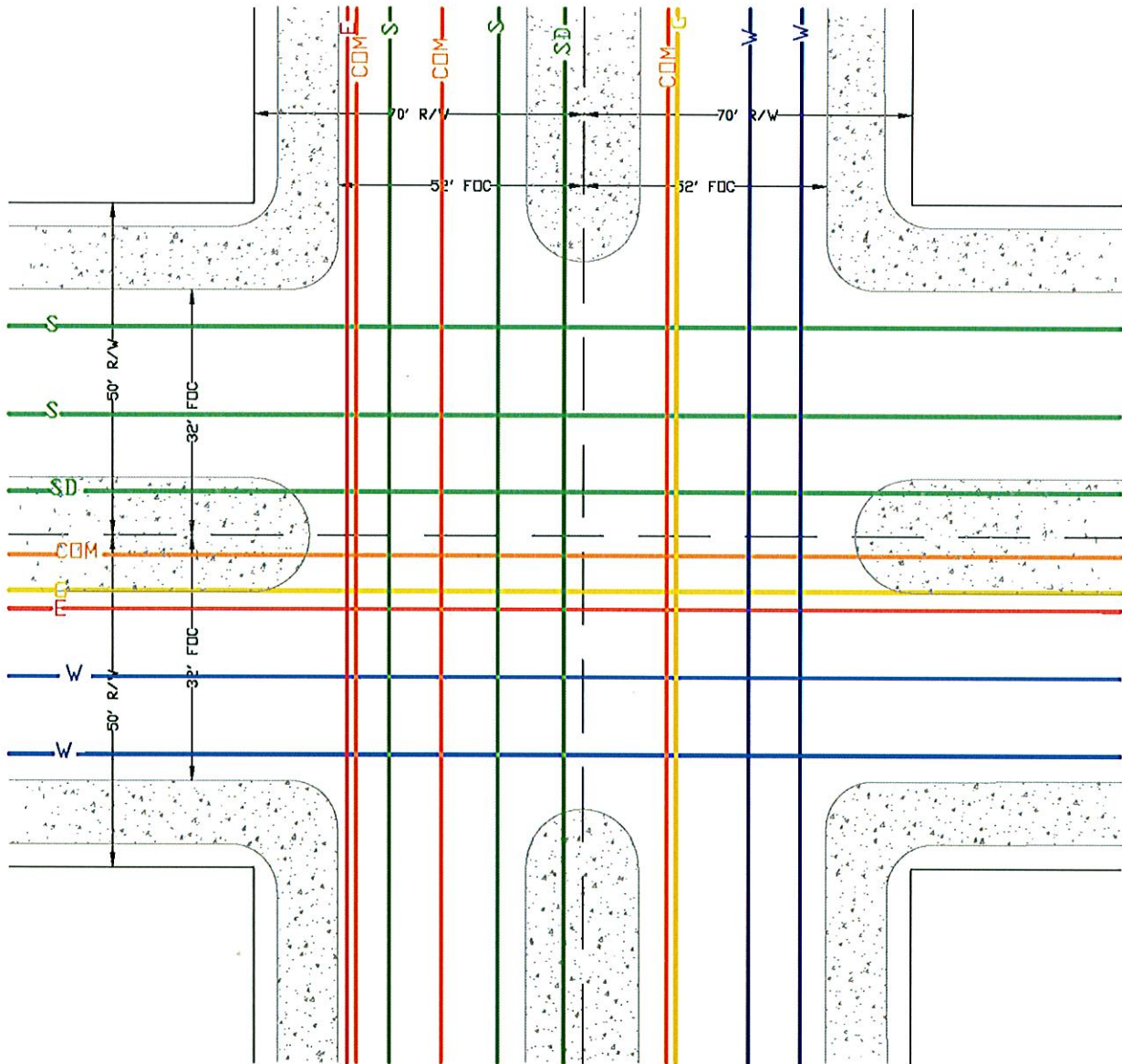

City of Phoenix

**STANDARD UTILITY DETAILS - PLAN VIEW
70' ROW / 50' ROW INTERSECTION
WITH MEDIAN ISLANDS**

ENGINEERING AND
ARCHITECTURAL SERVICES
DEPARTMENT

DATE
7/28/2004

DRAWN BY
THOMAS FISHER

DRAWING NO.
M

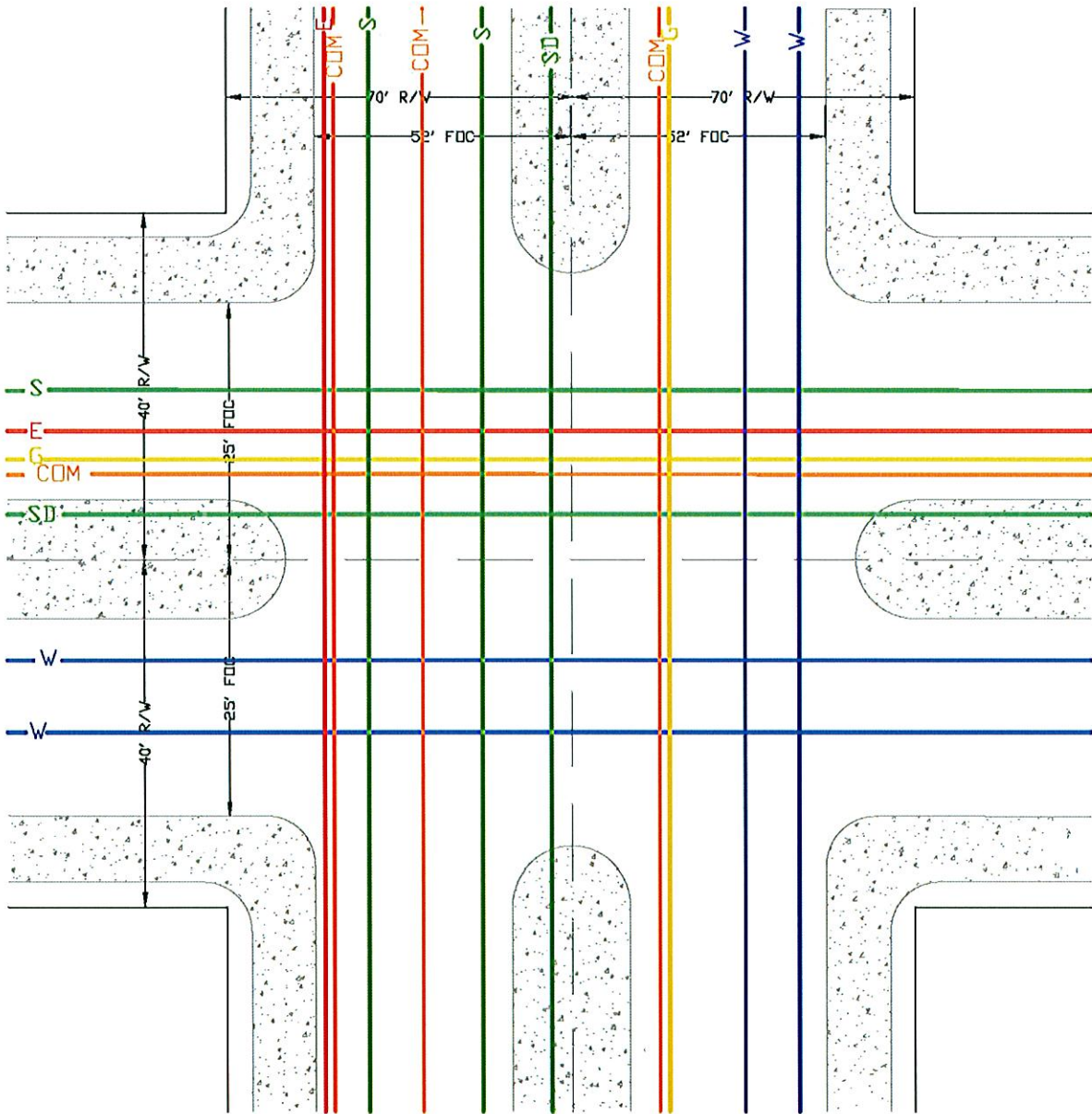

**STANDARD UTILITY DETAILS -
PLAN VIEW 70' ROW / 40' ROW INTERSECTION
WITH MEDIAN ISLANDS**

ENGINEERING AND
ARCHITECTURAL SERVICES
DEPARTMENT

DATE
7/28/2004

DRAWN BY
THOMAS FISHER

DRAWING NO.
N

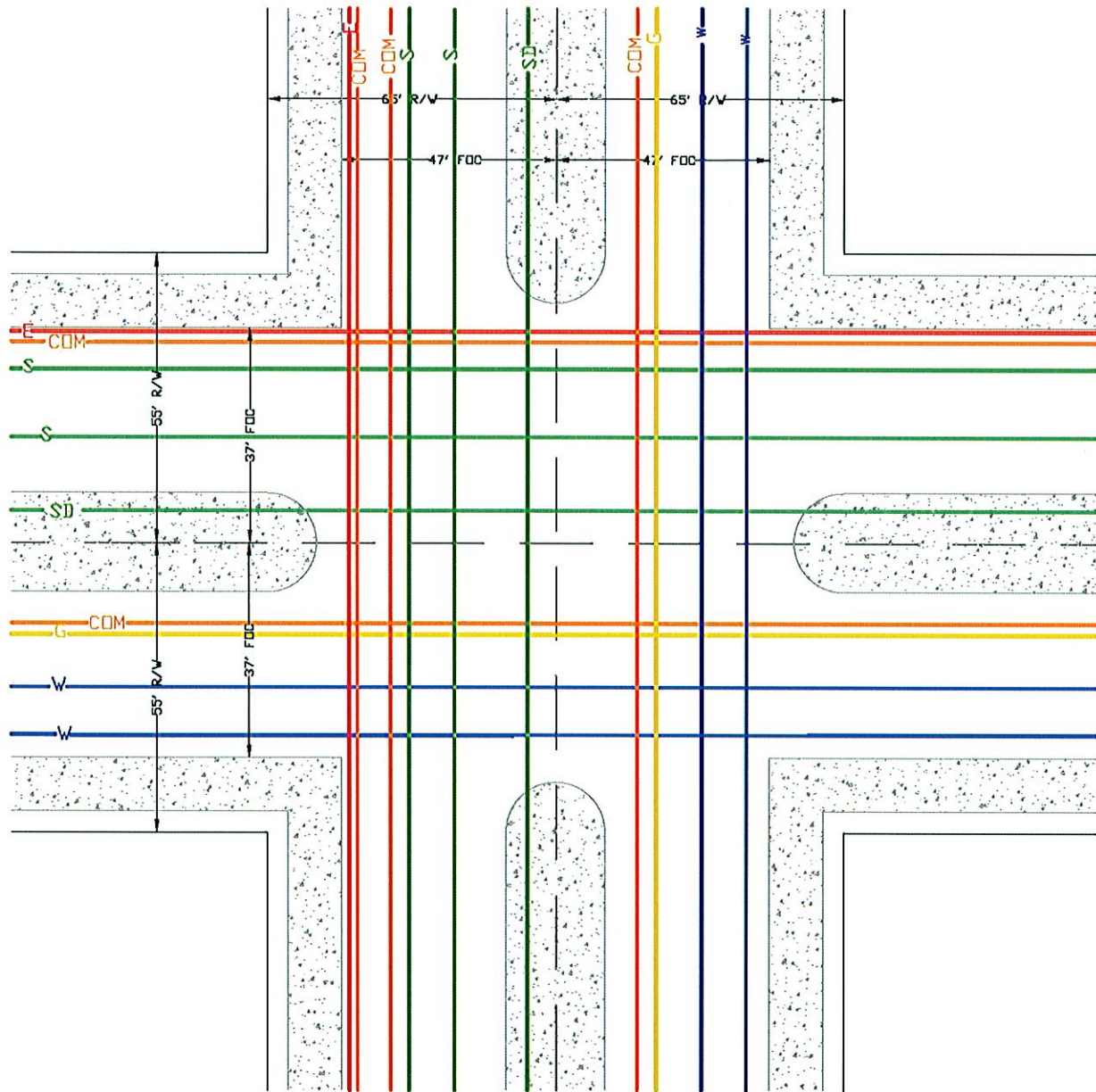

**STANDARD UTILITY DETAILS -
PLAN VIEW 65' ROW / 55' ROW INTERSECTION
WITH MEDIAN ISLANDS**

ENGINEERING AND
ARCHITECTURAL SERVICES
DEPARTMENT

DATE
7/29/2004

DRAWN BY
THOMAS FISHER

DRAWING NO.
0

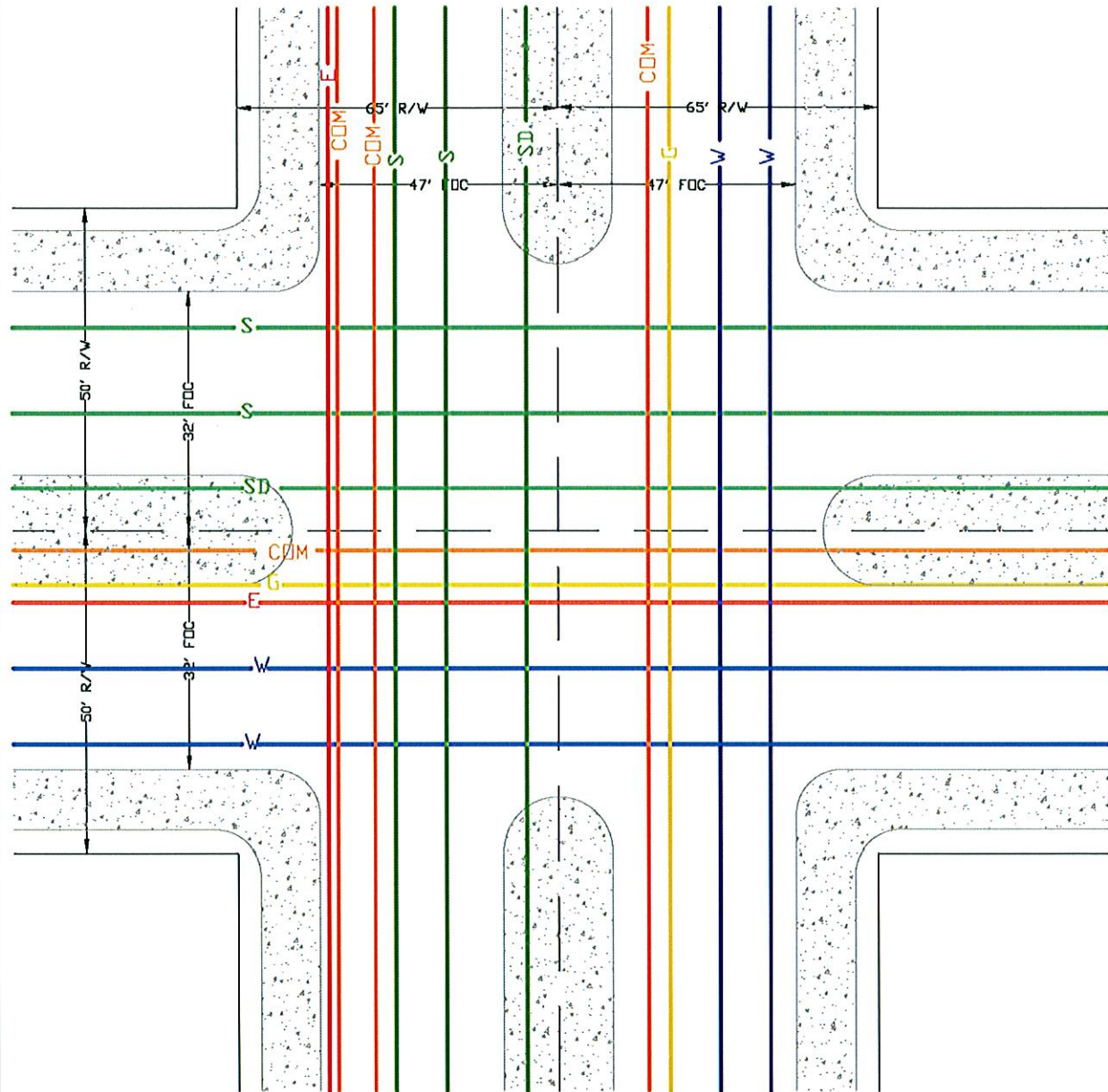

**STANDARD UTILITY DETAILS -
PLAN VIEW 65' ROW / 50' ROW INTERSECTION
WITH MEDIAN ISLANDS**

ENGINEERING AND
ARCHITECTURAL SERVICES
DEPARTMENT

DATE
7/28/2004

DRAWN BY
THOMAS FISHER

DRAWING NO.
P

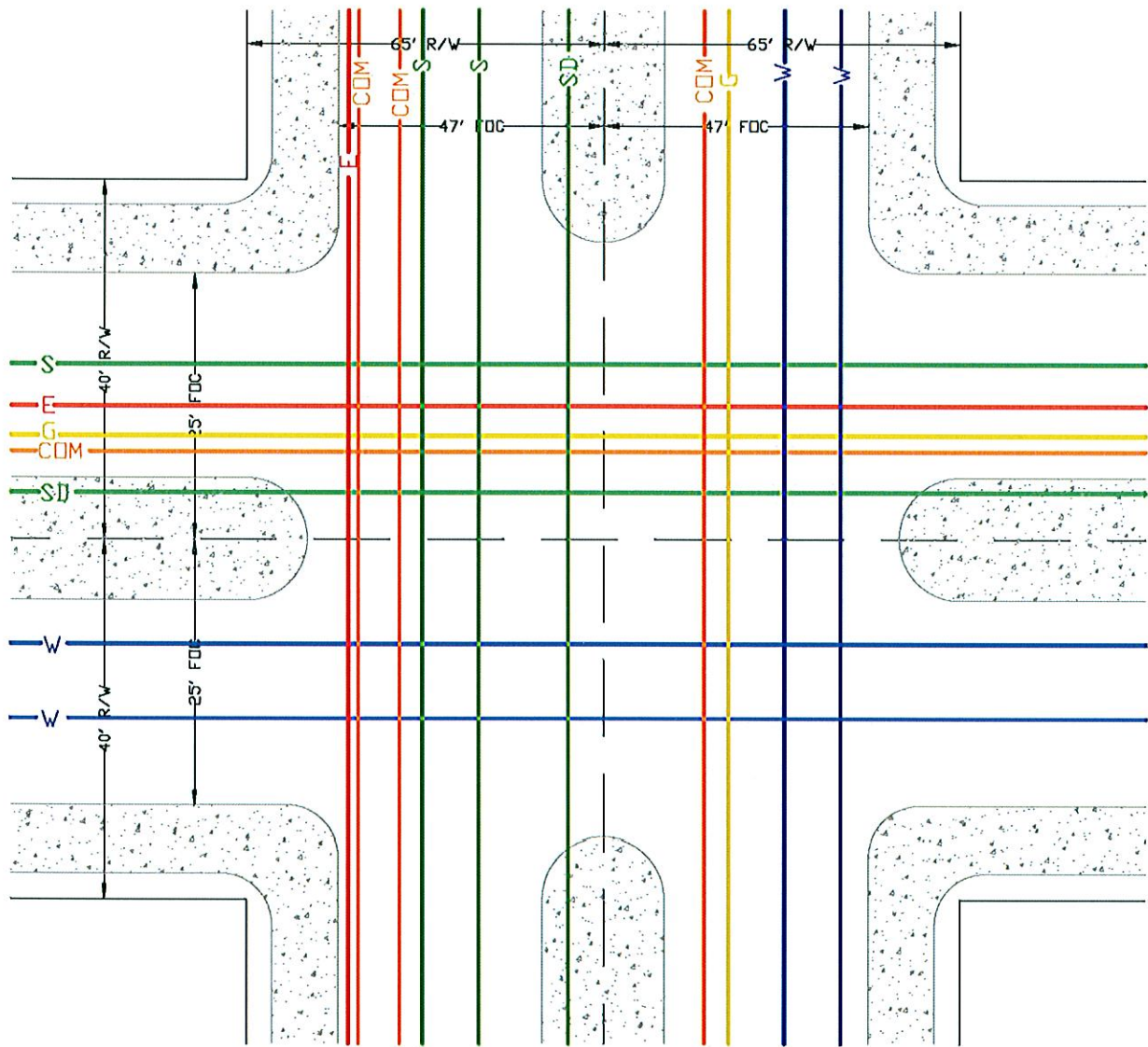

**STANDARD UTILITY DETAILS -
PLAN VIEW 65' ROW / 40' ROW
INTERSECTION WITH MEDIAN ISLANDS**

ENGINEERING AND
ARCHITECTURAL SERVICES
DEPARTMENT

DATE
7/28/2004

DRAWN BY
THOMAS FISHER

DRAWING NO.
Q

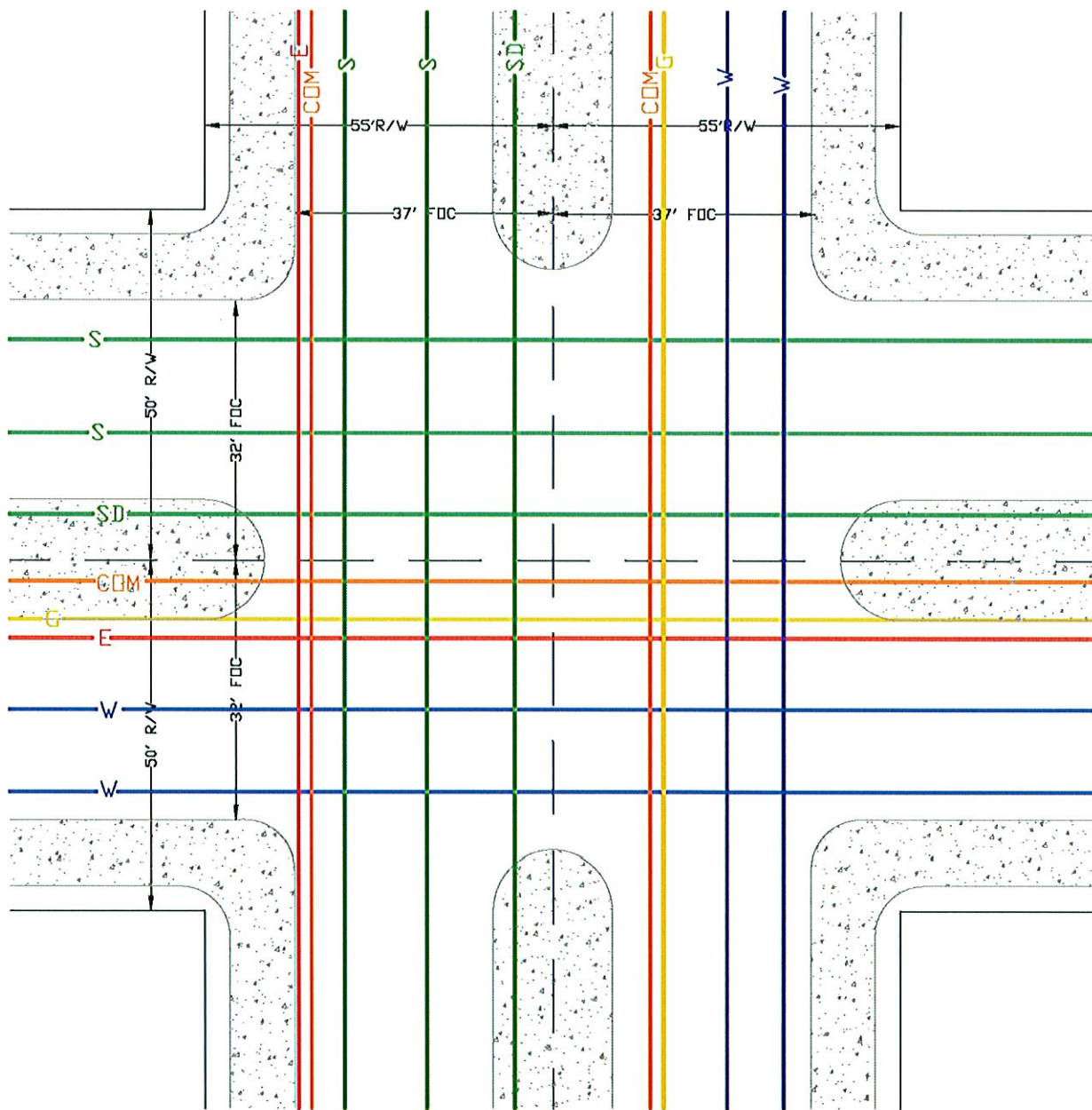

**STANDARD UTILITY DETAILS -
PLAN VIEW 55' ROW / 50' ROW INTERSECTION
WITH MEDIAN ISLANDS**

ENGINEERING DEPARTMENT	DATE 7/28/2004	DRAWN BY THOMAS FISHER	DRAWING NO. R
---------------------------	-------------------	---------------------------	------------------

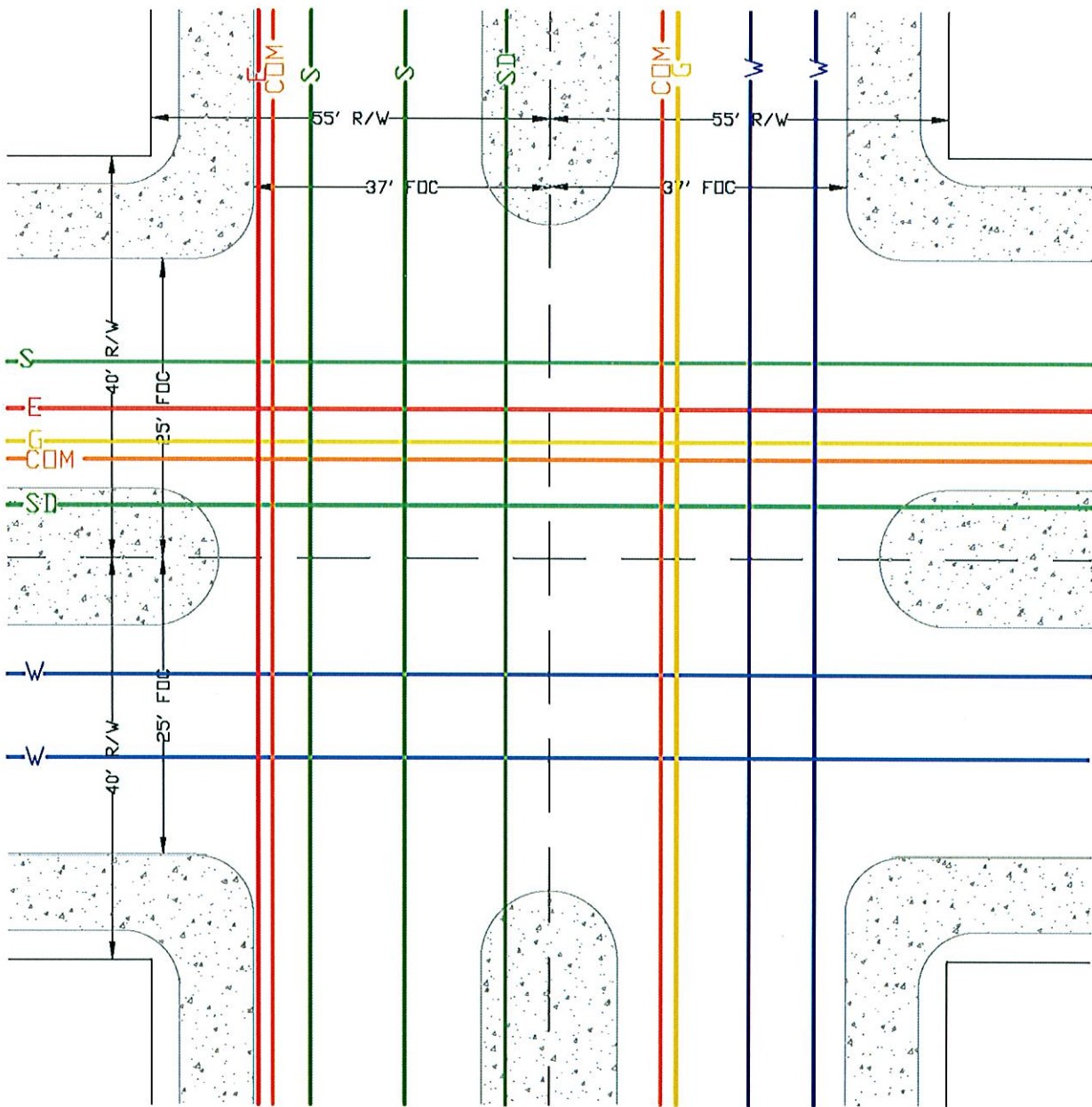

**City of
Phoenix**

**STANDARD UTILITY DETAILS -
PLAN VIEW 55' ROW / 40' ROW
INTERSECTION WITH MEDIAN ISLANDS**

ENGINEERING
DEPARTMENT

DATE
7/28/2004

DRAWN BY
THOMAS FISHER

DRAWING NO.
S

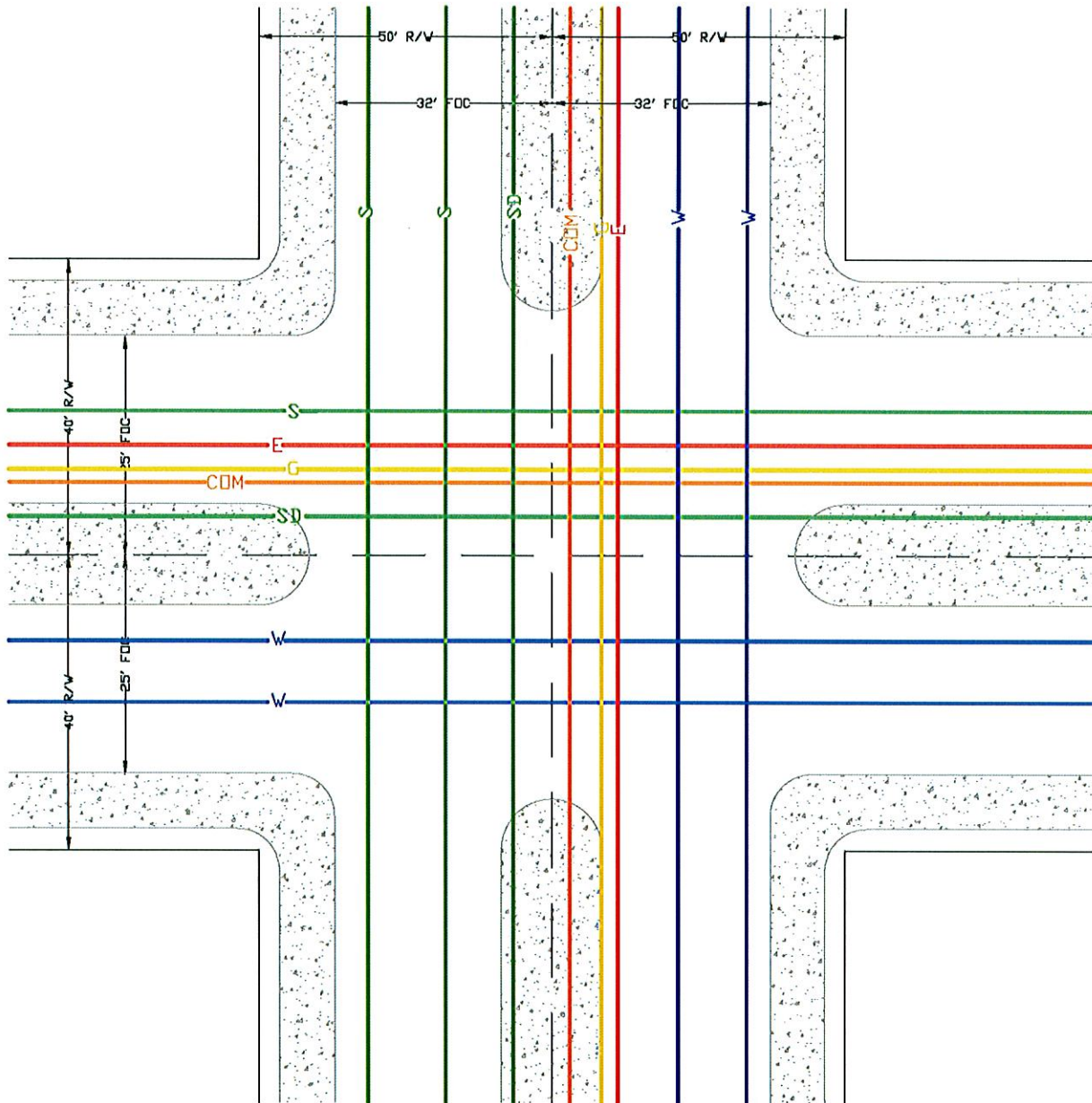

**STANDARD UTILITY DETAILS -
PLAN VIEW 50' ROW / 40' ROW
INTERSECTION WITH MEDIAN ISLANDS**

ENGINEERING DEPARTMENT	DATE 7/29/2004	DRAWN BY THOMAS FISHER	DRAWING NO. T
------------------------	-------------------	---------------------------	------------------



SPECIAL ACKNOWLEDGEMENTS

The City of Phoenix, in preparing this manual, wishes to acknowledge that these standard utility locations could not have been developed without the interest and cooperation of the following agencies and the special efforts of their representatives:

Lois Winkler	Arizona Public Service
Pom Jintasawang	Southwest Gas Corporation
Emily Ng	Arizona State University
Daniel Eden	City of Phoenix
Brent White	City of Phoenix